

Global EHS Plant, Machinery & Tool Guidebook

© 2020 Micron Technology, Inc. All rights reserved. Information, products, and/or specifications are subject to change without notice. All information is provided on an “AS IS” basis without warranties of any kind. Statements regarding products, including statements regarding product features, availability, functionality, or compatibility, are provided for informational purposes only and do not modify the warranty, if any, applicable to any product. Drawings may not be to scale. Micron, the Micron orbit logo, the M orbit logo, Intelligence Accelerated™, and other Micron trademarks are the property of Micron Technology, Inc. All other trademarks are the property of their respective owners.



Intent of Guidebook

The intent of the guidebook is to assist the vendors and contractors to:

- Understand hazards associated with the plant, machinery and tools that they use to perform work
- Help the vendors and contractors to identify safe and unsafe plant, machinery and tools
- Communicate safe practices
- Prevent the use of unsafe, altered or modified plant, machinery and tools

Expectations

The vendors and contractors are expected to:

- Adopt and apply requirements outlined in this Guidebook and related Micron Standard even where these impose a higher standard than local legislations.
- This guidebook shall be included as part of the EHS requirement in contract agreement.

Note: *If further clarification is required, please approach Global EHS Construction EHS team for assistance.*

Contents



Plant and Machinery

- Crane
- Boom Lift and Scissors Lift
- Excavator
- Heavy Truck
- Air Compressor
- Generator
- Welding Machine
- Overhead Crane
- Other mobile equipment

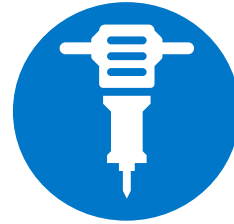

Power Tools

- Portable grinder
- Drill and Drill press
- Table mounted saw
- Portable cutter
- Portaband saw
- Reciprocating sawzall
- Explosive power tool



Hand Tools



Plant and Machinery

Plant and Machinery



General requirements for Plant and Machinery

1. *Hazard Identification & Risk Assessment carried out*
2. *Driver/Operator shall possess all license/certificate require by local legislations. This also applied to other members of the team. For example, rigger and signman of a lifting team.*
3. *If there is no legal requirement on licensing and training, it shall be the responsibility of employer to ensure competency of operator, either through in-house training, or training provided by 3rd parties, manufacturer, etc.*
4. *Monthly inspection Program in-place and implemented. A label/sticker should be used to indicate plant or machine had been inspected and the owner's company name.*
5. *Always perform a daily pre-use inspection on the plant or machinery.*
6. *Maintenance regime followed*
7. *Spotter or traffic warden assigned when necessary, to guide driver/operator, and control traffic*

Crane



1. *Work area effectively barricaded with warning sign*
2. *All required certificates & inspection reports available*
3. *Approved Permit-To-Work in place before operation*
4. *Approved lifting plan in place*
5. *Check for ground condition and overhead obstruction*
6. *DO NOT overload the crane*
7. *Tag line & shepherd's hook provided*
8. *PTP carry out before commencing work*
9. *Safety devices in good working condition*

Critical Lift Plan Overhead Crane		
Location: _____		Date of Lift: _____
Load Description: _____		
Qualified Person-In-Charge: _____		
A. LOAD 1. Load Condition New _____ Used _____ 2. Wt. Empty _____ lb 3. Wt. of Contents _____ lb 4. Wt. of Lifting Beam _____ lb 5. Wt. of Sling/Shackles _____ lb 6. Wt. of Excess Load Material _____ lb 7. Other _____ lb Total Weight of All Combined _____ lb Source of Load Wt. Information: (Drawgs, Calcs, etc.) _____ Load Wt. Confirmed by: _____		F. CONSIDERATIONS 1. If Lift Exceeds 75% of Crane's Capacity, Attach Additional Special Instructions/Restrictions, Diagrams for Crane, Rigging, Lift, etc., Yes ___ No ___ 2. Multiple Crane, Hook or Trolley Lifts Requires a Separate Plan for Each Crane. 3. Any Changes in the Crane Configuration, Load, Placement, Rigging, Lifting Scheme, or Calcs, Require that a New Critical Lift Plan be Developed.
B. CRANE 1. Type of Crane _____ 2. Maximum Crane Capacity _____ 3. Max. Weight to be Lifted is _____ lb 4. Travel, Trolley Restrictions? Yes ___ No ___ 5. LRT is _____ % of the Crane's Capacity 6. Other _____		G. PRE-LIFT CHECKLIST (COMPLETE PRIOR TO LIFT) 1. Crane Inspected _____ 2. Rigging Inspected _____ 3. Host Height _____ 4. Head Room _____ 5. Load Test _____ 6. Operator Qualification _____ 7. Rigging Qualification _____ 8. Signal System _____ 9. Tag Lines _____ 10. Wind/Temp. _____ 11. Safety Spotter _____ 12. Traffic _____ 13. Tailboard _____ 14. Site Control _____ 15. Signatures _____
C. Crane Hook (select one below) 1. Main _____ Aux 1 _____ Aux 2 _____ 2. Capacity of Crane Hook from C1 is _____ tons		H. Contingency Plans I. Emergency Action Plans
D. RIGGING 1. Hitch Type(s) _____ Size _____ 2. No. of Slings _____ 3. Sling Type WR _____ FW _____ RS _____ Chen _____ 4. Sling Assembly Rated Capacity _____ lb 5. Shackle Size(s) _____ 6. Shackle Rated Capacity(s) _____ 7. Shackle Secured to Load by: _____ 8. Shackle to Lifting Lug Mating OK? _____		
E. CRANE OPERATING AREA 1. Obstacles/Obstructions _____ 2. Other _____		Signature _____ Date _____ Signature _____ Date _____ Signature _____ Date _____ Signature _____ Date _____

© Copyright IPIA/ITB/Industrial Group 2004

Industrial Training International, Inc.
1.888.587.8472

iti.com/bookstore
ITEM #9150

Page 1 of 4
R0314



Boom & Scissors Lift



1. *Boom/Scissors lift work envelope barricaded*
2. *Warning sign in place*
3. *Spotter trained on emergency operation of the equipment*
4. *Approved Permit-To-Work in place before operation*
5. *Crush barrier in place*
6. *Fire Extinguisher in place*
7. *Check for ground condition and overhead obstruction*
8. *DO NOT overload work platform*
9. *Adhere to Fall Prevention Plan*
10. *Authorized Examiner Certification*
11. *Safety devices in good working condition*

Piling Machines



Micro Piling



Hammer Piling



Hydraulic Rotary
Piling



Driven Pile

1. *Work area effectively hard barricaded with adequate “no-entry” warning sign.*
2. *Required certificates of fitness, certificate of competency & inspection reports made available during premobilization and throughout the project duration.*
3. *If the machine does not fall under local legislations for certification and inspection, responsible company (GC/Contractor) shall engage a qualified third-party inspection company or a competent person to carry out inspection of such machine prior to mobilization to site.*
4. *The pile lines and pulley blocks must be inspected by the supervisor/foreman for any type of defects or wear and tear, before the beginning of each shift,*
5. *Any defective parts of piling machine, such as mechanical slings, sheaves, and hose shall be repaired only by qualified persons and re-inspected by the competent person.*
6. *Approved Permit-To-Work in place before operation*
7. *Approved Method Statement in place*
8. *Check for ground condition and overhead obstruction*
9. *Only use the piling machine for its designed purpose.*
10. *Tag line & shepherd’s hook provided when lifting pre-cast piles.*
11. *PTP carried out before commencing work*
12. *Safety devices are in good working condition. Defective machines shall be removed from active worksite.*
13. *When performing PDA test, the test measurement shall be taken remotely using appropriate monitoring device.*

Excavator



1. *Work area around the excavator barricaded*
2. *Warning sign in place*
3. *Spotter trained on emergency operation*
4. *Approved Permit-To-Work in place before operation*
5. *Fire Extinguisher in place*
6. *Check for ground condition and overhead obstruction*
7. *Cabin certified for Roll Over and Falling Object Protection.*
8. *Authorized Examiner Certification*
9. *Where applicable, CCTVs installed*
10. *Operator's view from the cabin is unobstructed*
11. *Safety devices in good working condition*

Heavy Trucks



1. *Adhere to site PPE requirement*
2. *Fire Extinguisher available*
3. *Check for ground condition and overhead obstruction*
4. *Load covered during transportation*
5. *Engine to be switched-off when idling, turn on hazard light.*
6. *Wheel chocked when engine turned off and vehicle is parked*
7. *Safe access and egress provided*
8. *Silt/soil washed off before vehicle leaves site*
9. *Safety devices in good working condition*



Air Compressor



1. *Low noise level*
2. *Fire Extinguisher available*
3. *Correct connecting fitting being used.*
4. *“R” pin and whiplash arrestor used to secure hose*
5. *Obtain design calculation and drawing endorsed by PE for lifting point*
6. *Drip tray provided underneath equipment*
7. *Valid certificate for air receiver.*
8. *Safety guard for moving/rotating parts in place and in good working condition*
9. *Safety devices in good working condition*



Generator

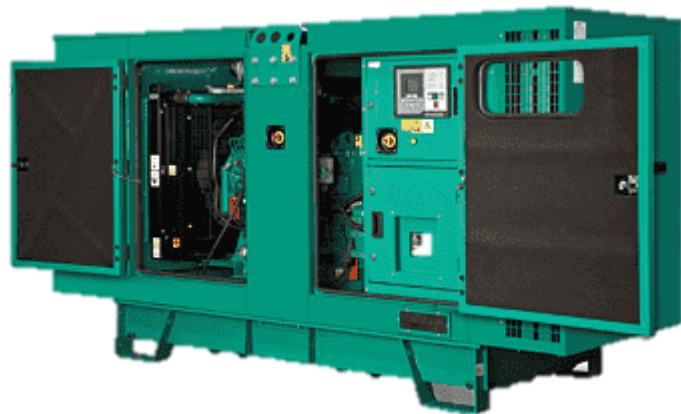

1. *Certified for low noise level*
2. *Fire Extinguisher available*
3. *CPR and authorized personnel poster displayed*
4. *Where applicable, license to operate displayed*
5. *Earthing rod properly fixed*
6. *Secondary containment available to hold oil spills*
7. *Obtain design calculation and drawing endorsed by PE for lifting points*
8. *The area secured with hard barricades preventing unauthorized entry*
9. *Distribution board is kept locked*
10. *Machinery is placed on stable ground*

Welding Machine



Purple Wave Auction

1. *Certified for low noise level*
2. *Fire Extinguisher available*
3. *Daily inspection including welding holder, return earth clamp completed before operation*
4. *Monthly inspection by Licensed Electrical Person.*
5. *Correct PPE to be worn.*
6. *Only to be operated by qualified welder*
7. *Earthing rod properly fixed*
8. *Secondary containment available to hold oil spills*
9. *Obtain design calculation and drawing endorsed by PE for lifting points*
10. *Work area should be well ventilated and keep dry.*
11. *Proper control on flying sparks and screening for flashing arc shall be provided.*
12. *Ensure no flammable materials around work area*

Forklift



1. *Work area effectively barricaded with warning sign*
2. *All required certificates & inspection reports available*
3. *Used for material handling ONLY*
4. *Check for ground condition and overhead obstruction*
5. *DO NOT overload the forklift*
6. *Safety devices in good working condition*
7. *Always give way to pedestrians*
8. *Always put on seat belt*
9. *Keep the load at low level and stationary when in motion*
10. *Passenger prohibited*



Overhead Crane



1. *All required certificates & inspection reports available*
2. *Used for material handling ONLY*
3. *DO NOT overload the crane*
4. *Safety devices in good working condition*
5. *Survey the area to plan the work so as to eliminate hazard of caught in-between, struck by/against the load.*
6. *Do not carry load over people.*
7. *Do not attempt to repair the crane unless you are trained and qualified to do so.*
8. *Crane should not be left unattended with suspended load.*



Other Mobile Equipment

Front end loader



Bulldozer

Roller



1. *Low noise level*
2. *Fire Extinguisher available*
3. *Competent Operator/driver.*
4. *The cabin is clean*
5. *Certified Roll Over Protection and Falling Object Protection System in place*
6. *Vision of the operator is unobstructed*
7. *Ensure machinery does not operate within restricted area of open cut excavation*
8. *Passenger prohibited*

Other Mobile Equipment



Tipper



Skid Steer Loader

1. *Low noise level*
2. *Fire Extinguisher available*
3. *Competent Operator/driver.*
4. *The cabin is clean*
5. *Certified Roll Over Protection and Falling Object Protection System in place*
6. *Vision of the operator is unobstructed*
7. *Ensure machinery does not operate within restricted area of open cut excavation*
8. *Passenger prohibited*

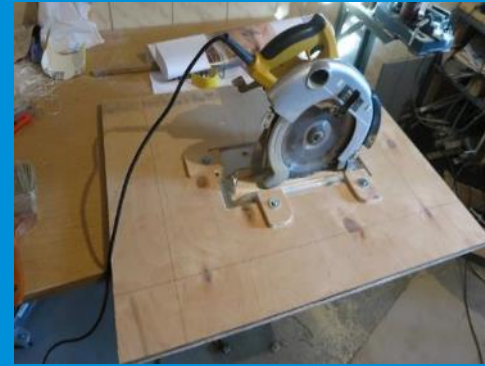

Power Tool

Electrical Power Tools



If local legislations stipulate requirement on specified PPE associated with certain power tool, the legislations shall take precedence.

General requirements for electrical power tools

1. *Hazard Identification & Risk Assessment carried out*
2. *Is used in accordance with the manufacturer's instructions*
3. *Training in the correct and safe use of tools is given to person assigned to use the tools*
4. *Electric hand tools must be double insulated and certified safe for use by an Authorized Electrical Worker*
5. *Monthly inspection Program in-place and implemented. A label/sticker should be used to indicate power tool had been inspected and the company own the tool.*
6. *Always perform a pre-use inspection on the tool.*
7. *Defective tools must not be used. It shall be tagged and removed from the work site immediately.*
8. *Tools have to be secured to the user with a lanyard or strings while working at height*
9. *License must be obtained for the use of explosive tools*

Electrical Power Tools

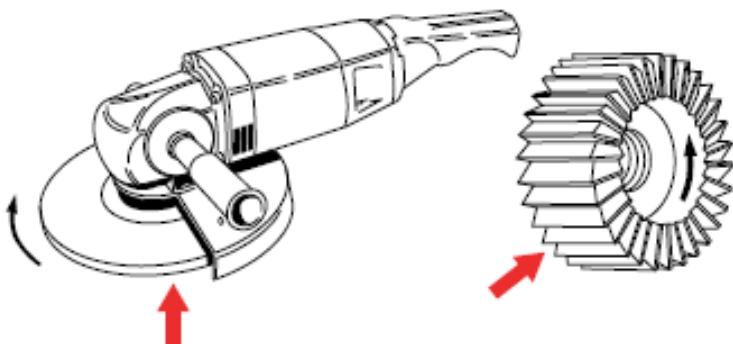
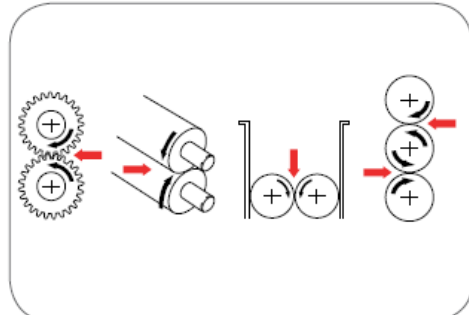
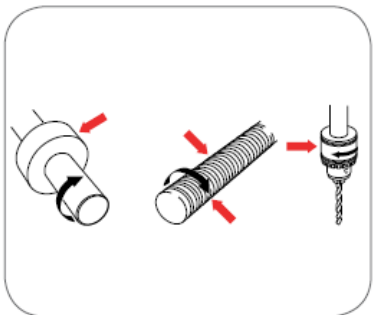

Prohibition – Usage of Gloves

1. *Hazard* When operating a moving machine, there is a risk of one's hand being accidentally caught and drawn into the machine. This may result in an amputation or crushing injury.
2. *In such circumstances, the use of gloves is prohibited, providing the safety features of the tool/equipment are in place and is in good working order.*
3. *Gloves without fingertips may be used for palm protection when operating low-speed moving machines (e.g., plate rolling machine) provided that effective protective and/or emergency stop devices are in place to reduce the risk associated with the hazardous situation*

Grinder/Cutter

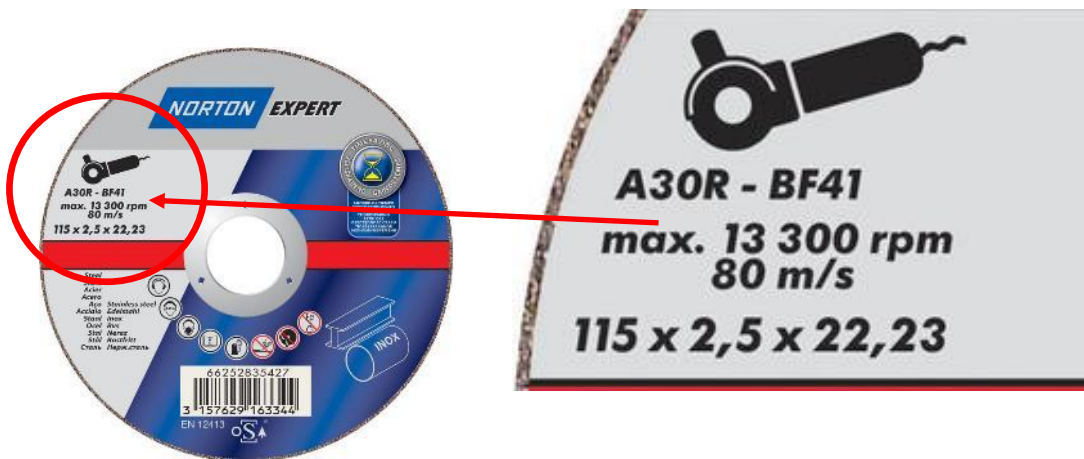

Dos

1. Use the tool only if you are trained.
2. Check the disc for expiry date and correct/compatible RPM
3. Use correct disc for the job for grinding/cutting.
4. Defective disc shall NOT be used.
5. Always wear your eye and face protection while grinding/cutting
6. Only tools with "Deadman's Switch" are allowed to be used at site.
7. Cut into the workpiece at a moderate, constant rate.
8. Fasten your work piece using a vice or clamp.

Don'ts

1. Don't remove handle or safety guard of the grinder
2. Don't hold work piece in one hand and tool in another hand while grinding or cutting.
3. Don't tighten by hand when changing disc. Use the correct tool for tightening
4. Don't use abrupt or excessive pressure while cutting or grinding
5. Don't use a cutting disc for grinding purpose.

Electrical Power Drill

Dos

1. *Select the bit or attachment suitable for the size of the drill and the work being done.*
2. *Ensure that the bit or attachments are properly seated and tightened in the chuck.*
3. *Use the auxiliary (second) handle for larger work or continuous operation.*
4. *Wear safety glasses or a face shield*
5. *Keep all cords clear of the cutting area during use. Inspect for frays or damage before each use.*
6. *Disconnect power supply before changing or adjusting bit or attachments.*
7. *Tighten the chuck securely. Remove chuck key before starting drill.*
8. *Secure workpiece being drilled to prevent movement.*



Don'ts

1. *Don't drill with one hand while holding the material with the other. Always secure the work piece.*
2. *Don't exceed the manufacturer's recommended maximum drilling capacities.*
3. *Don't attempt to free a jammed bit by starting and stopping the drill. Unplug the drill and then remove the bit from the workpiece*
4. *Don't raise or lower the drill by its power cord.*
5. *Don't use excessive force to drill into hard material. Reduce drill speed if possible.*
6. *Don't wear loose clothing or gloves, keep long hair tied back. These items will get caught in bit or spindle*

Drill Press

Dos

1. *Always wear your safety glasses or a face shield.*
2. *Consult your supervisor on the correct speed and bit size.*
3. *Tighten the bit evenly into the chuck on all three sides as tight as possible with the key alone. Never use anything other than the key to tighten chuck.*
4. *Clamp or secure piece onto table with means other than your hands.*
5. *Stop the drill press before removing any work*
6. *If machine is malfunctioning stop immediately and report to supervisor.*



Don'ts

1. *Don't operate the equipment unless you are trained to do so*
2. *Don't wear loose clothing or gloves, keep long hair tied back. These items will get caught in bit or spindle*
3. *Never adjust the drill press or setup while it is running*
4. *Don't leave chuck key in press. It should only be on the chuck when power is off and you are changing a bit..*
5. *Don't use excessive force on the bit. Let it cut at its own rate.*
6. *Don't hold pieces to drill them. It should be secured by clamp or vice.*
7. *Don't add anything to the drill press other than the standard drill press equipment*



Table Mounted Saw



Dos

1. *Use the tool only if you are trained.*
2. *Check the blade for defect before commencing work*
3. *Check the safety guard for proper working condition before commencing work.*
4. *Stay attentive while cutting.*
5. *Always wear your eye protection and dust mask*
6. *Always turn off power and un-plug when not in-use.*
7. *Use a push stick to keep fingers away from the saw blade.*

Don'ts

1. *Don't take your eye off the work piece where you're cutting - that's how you lose fingers.*
2. *Don't remove safety guard of the saw*
3. *Don't use your hand to adjust the work piece during cutting .*
4. *Don't try to repair, adjust the tool without un-plug the power supply.*

Portable Cutter



Dos

1. *Use the tool only if you are trained.*
2. *Check the cutting disc for defect before commencing work*
3. *Check the safety guard for proper working condition before commencing work.*
4. *Stay attention while cutting.*
5. *Always wear your eye protection and face shield*
6. *Always turn off power and un-plug when not in-use.*
7. *Check work environment and take action against fire hazard, for example, sparks containment.*

Don'ts

1. *Don't apply excessive much force.*
2. *Don't remove safety guard of the saw*
3. *Don't use your hand to adjust the work piece during cutting .*
4. *Don't try to repair, adjust the tool without un-plug the power supply.*

Portaband



Dos

1. *Purchase the right tool*
2. *Keep work area safe*
3. *Wear appropriate PPE*
4. *Hold the reciprocating saw firmly with both hands or clamp the workpiece on a table*
5. *Use only a Ground Fault Circuit Interrupter (GFCI) protected extension cords or outdoor outlets.*
6. *When you are cleaning or changing blades, turn off the power supply and unplug it.*
7. *Keep your hands clear of the saw*

Don'ts

1. *Don't operate an electric porta band in wet conditions*
2. *Don't plug it into an outlet without ensuring that the switch is off.*
3. *Don't use excessive force or overreach when operating the reciprocating saw*
4. *Don't leave the tool unattended*
5. *Don't use the Saw if You Feel Unwell*
6. *Don't use a porta band in an area where combustible materials are stored*
7. *Don't remove guards*

Reciprocating Sawzall



Dos

1. *Purchase the right tool*
2. *Keep work area safe*
3. *Wear appropriate PPE*
4. *Hold the reciprocating saw firmly with both hands or clamp the workpiece on a table*
5. *Use only a Ground Fault Circuit Interrupter (GFCI) protected extension cords or outdoor outlets.*
6. *When you are cleaning or changing blades on the reciprocating saw, turn off the power supply and unplug the saw.*
7. *Keep your hands clear of the saw*

Don'ts

1. *Don't operate an electric reciprocating saw in wet conditions*
2. *Don't plug it into an outlet without ensuring that the switch is off.*
3. *Don't use excessive force or overreach when operating the reciprocating saw*
4. *Don't leave the tool unattended*
5. *Don't use the Saw if You Feel Unwell*
6. *Don't use a reciprocating saw in an area where combustible materials are stored*

Explosive Power Tool

(Powder actuated tool)



This tool drive studs by power from an explosive charge. Their operation is similar to a firearm and they can be just as dangerous if used carelessly.

Hazards Involved

1. *Flying particles of dirt or scale, or particles discharged from the work surface the stud enters.*
2. *Using too heavy a charge for the material. This can result in the stud being shot completely through the work.*
3. *Studs ricocheting if the tool is not held properly or is being used on too hard a material.*
4. *Fire hazards from using the tool when flammable or explosive dust or fumes are present.*
5. *Using the tool powder charges in firearms or using firearm blanks in powder-actuated tools.*

Before Use

1. *Inspect your tool everyday before use.*
2. *Conduct a dry test as per manufacturer's manual.*
3. *Understand the type of materials you are driving into*
4. *Understand what is inside the wall and what is on the other side of the wall.*

Explosive Power Tool

(Powder actuated tool)



What must you do

1. Only load your tool immediately before firing.
2. Always point your tool downward.
3. Understand the job from the method statement and JHA
4. Always keep powder-actuated tools, studs, and cartridges in a safe place under lock & key when not in-use.
5. Always wear adequate eye protection when using these tools. This applies to both you and your co-worker.
6. Barricade the area and display warning sign



Explosive Power Tool

(Powder actuated tool)



What you mustn't do

1. *Never carry a loaded tool from one job to another.*
2. *Never point the tool to anyone.*
3. *Never start a job without proper planning.*
4. *Don't leave tool or accessories unattended even for a short period of time.*
5. *Don't drop or throw powder-actuated tools. This can cause accidental discharge..*
6. *Never try to release a loaded tool that has jammed in the firing position. Place it in a safe place and contact the manufacturer's representative.*

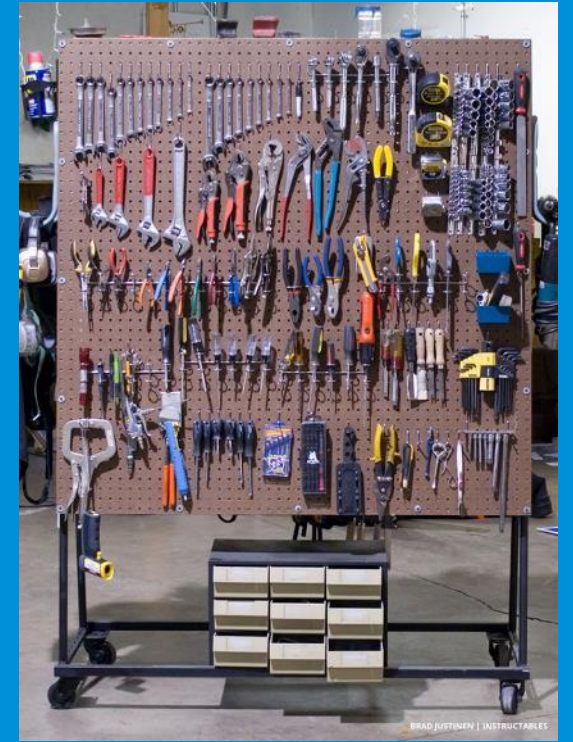

Hand Tool

Hand Tools



Dos

1. Always wear the **RIGHT PPE** for the job and tools used.
2. Use tools that are the **RIGHT SIZE & RIGHT TYPE** for your job
3. Follow the correct procedure for using **EVERY** tool.
4. Handle **SHARP-EDGED** and **POINTED TOOLS** with care
5. Carry all sharp tools in sheath or holsters
6. **AFTER USING A TOOL** — clean it and return it to its proper storage place
7. Cut away from yourself when you use chisels and other edged tools.
8. When handing a tool to another person, direct sharp points and cutting edges away from yourself and the other person

Hand Tools



Don'ts

1. Don't work with **OILY** or **GREASY** hands.
2. **NEVER** carry tools in your pockets
3. Don't use tools which are **LOOSE** or **CRACKED**
4. Don't use a file without a proper **HANDLE**.
5. Don't use screwdrivers as **CHISELS** or **PRY BAR**
6. Don't connect two wrenches to increase leverage
7. Don't use tools for things they weren't meant for.
8. Don't perform "make-shift" repairs to tools. Remove tools from site.
9. Don't throw tools from one location to another or from one employee to another.

Hand Tools

Some useful tips to remember:

- Never use a tool with mushroom head.
 - Never use a screwdriver as a chisel
 - Never connect two wrenches to form an extension
 - Never use a screwdriver or file as a pry bar.
 - Never hammer a wrench for tightening
 - Never use a self-made tool
-
- Use cable stripper, not a knife
 - Use the ring, not the open end of wrench to avoid slip off
 - Use insulated tool for electrical work

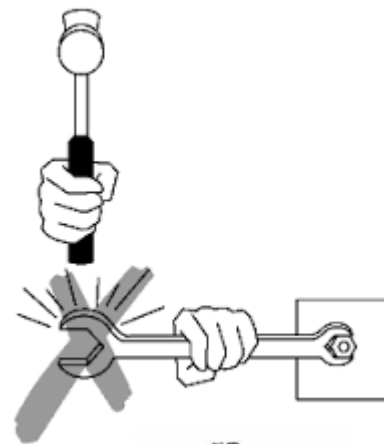

Mushroom Head

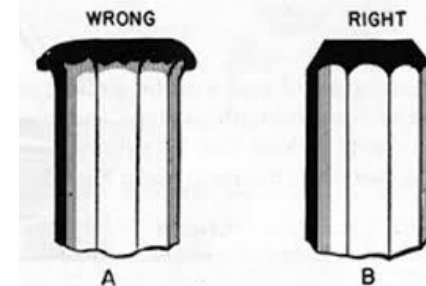

Use the Right Tool for the Right Job

